

K I O W U
C N W H P D F

Alphabet A to Z



Name: _____

Date: _____

Alphabet A to Z

Color the drawing and trace the word

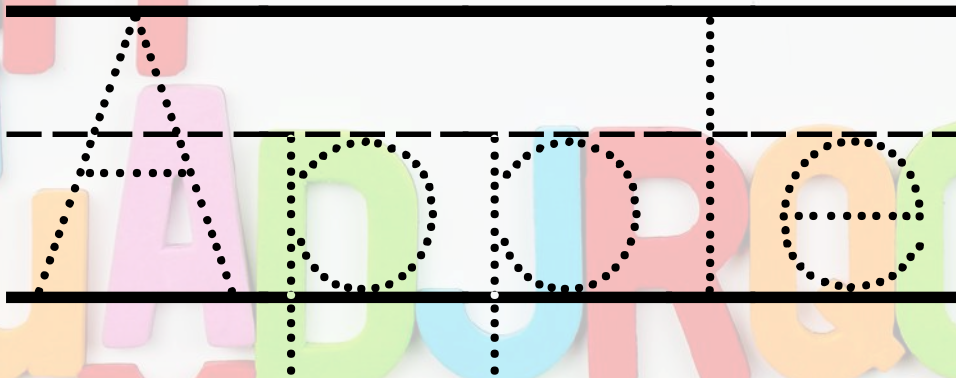
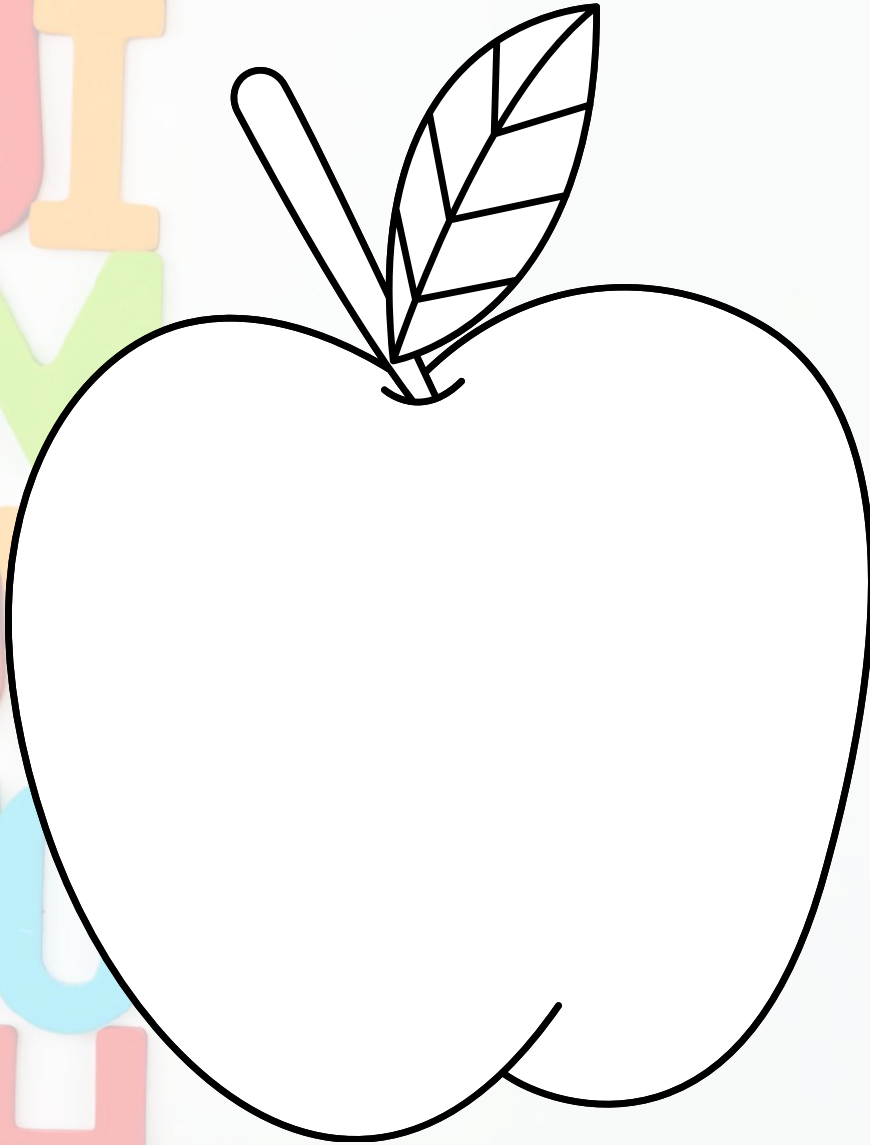

Name: _____

Date: _____

Alphabet A to Z

Color the drawing and trace the word

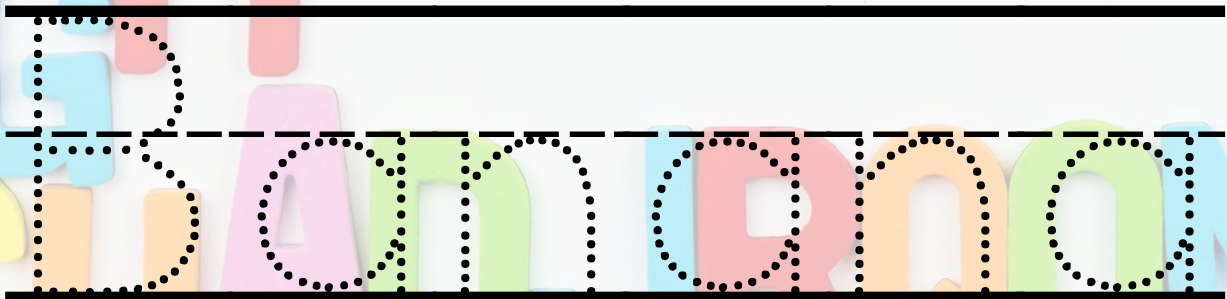
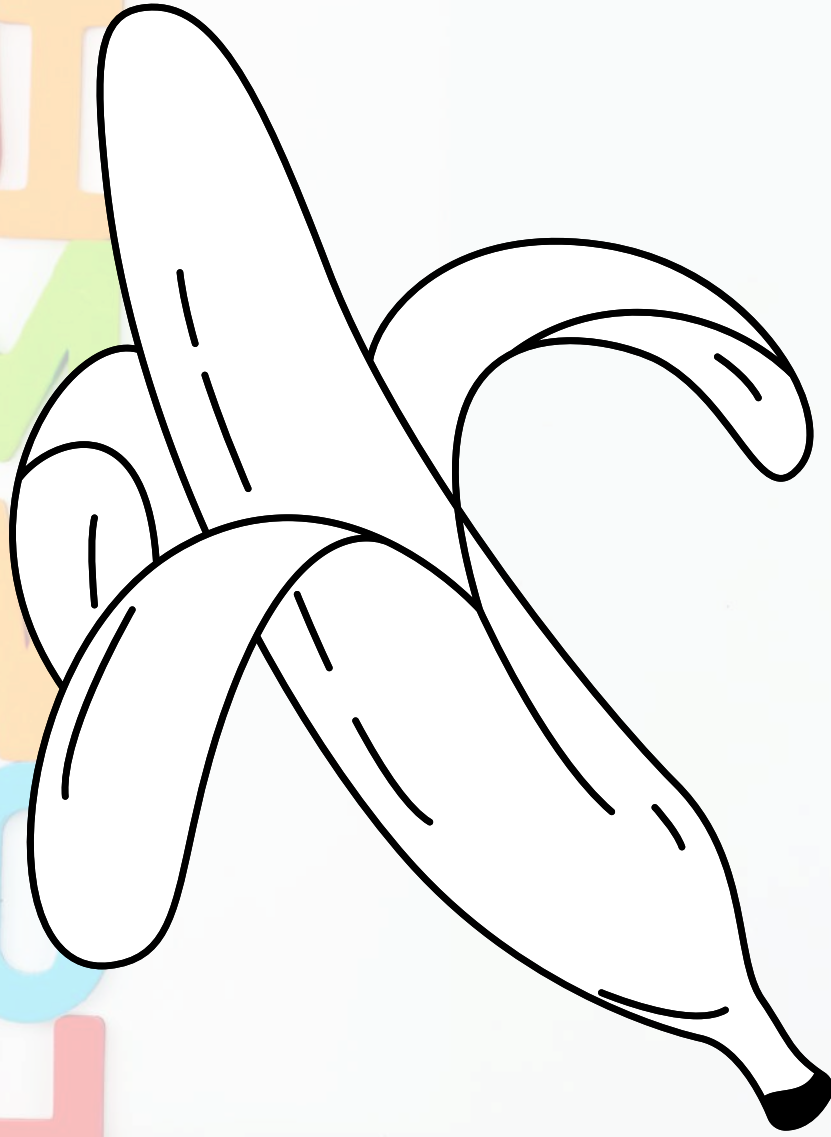

Name: _____

Date: _____

Alphabet A to Z

Color the drawing and trace the word

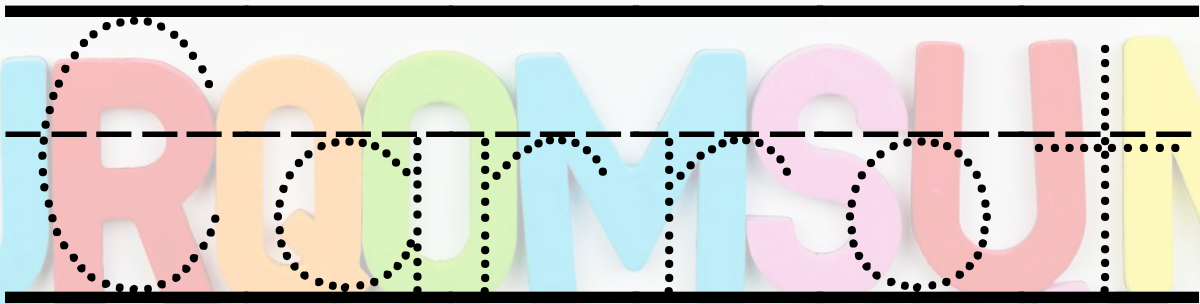
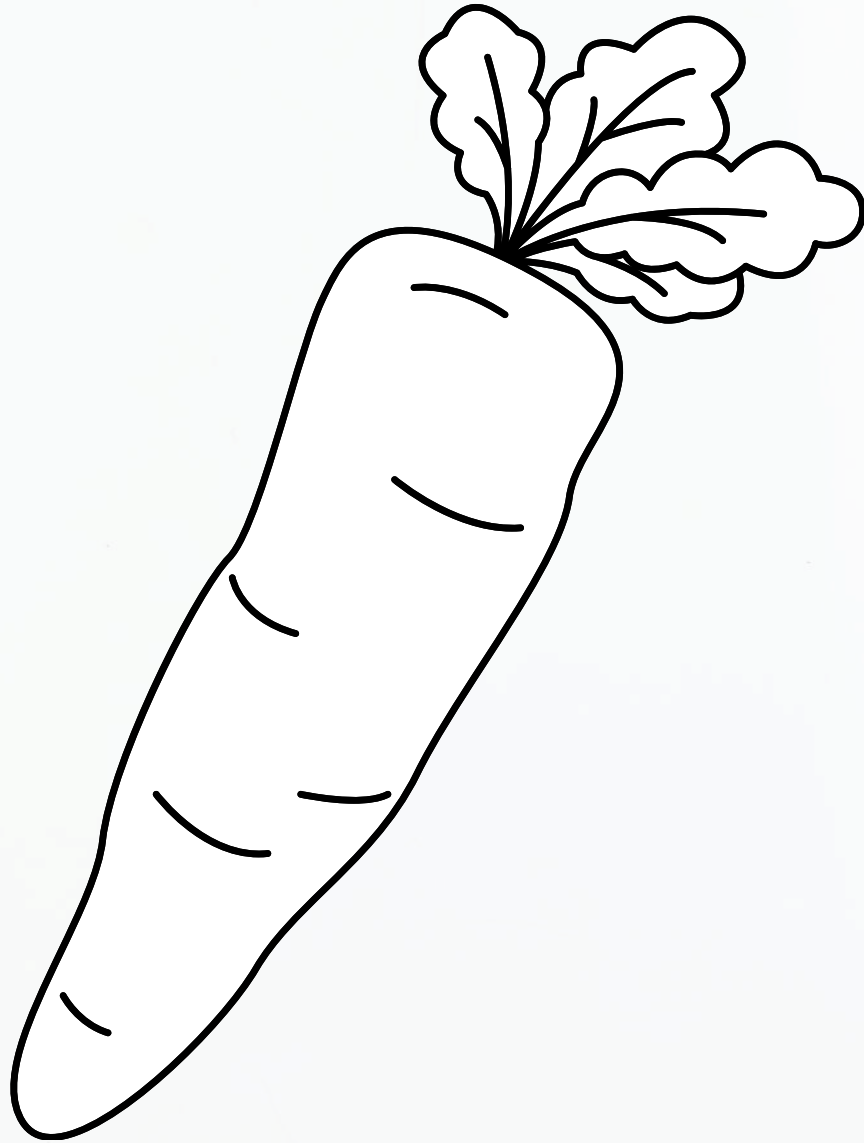

Name: _____

Date: _____

Alphabet A to Z

Color the drawing and trace the word

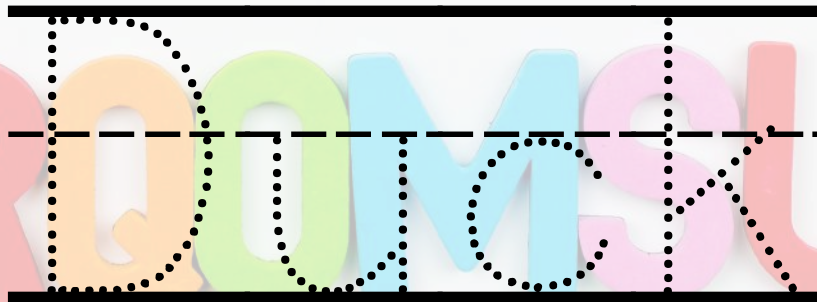
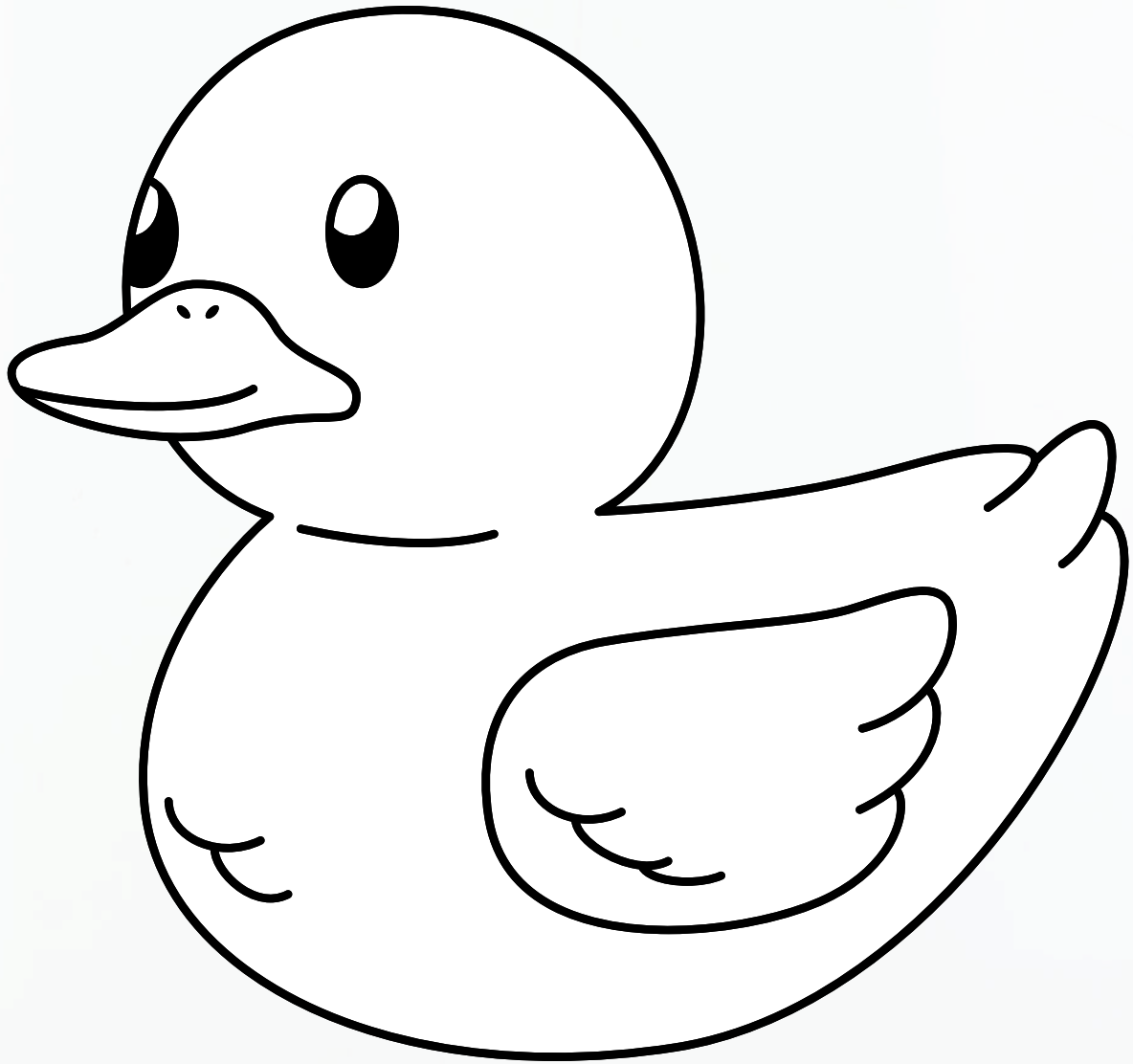

Name: _____

Date: _____

Alphabet A to Z

Color the drawing and trace the word

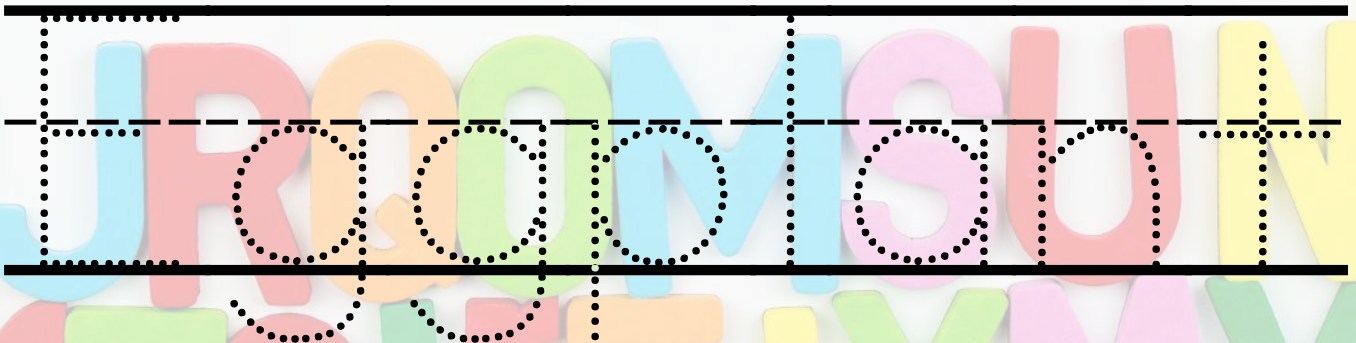
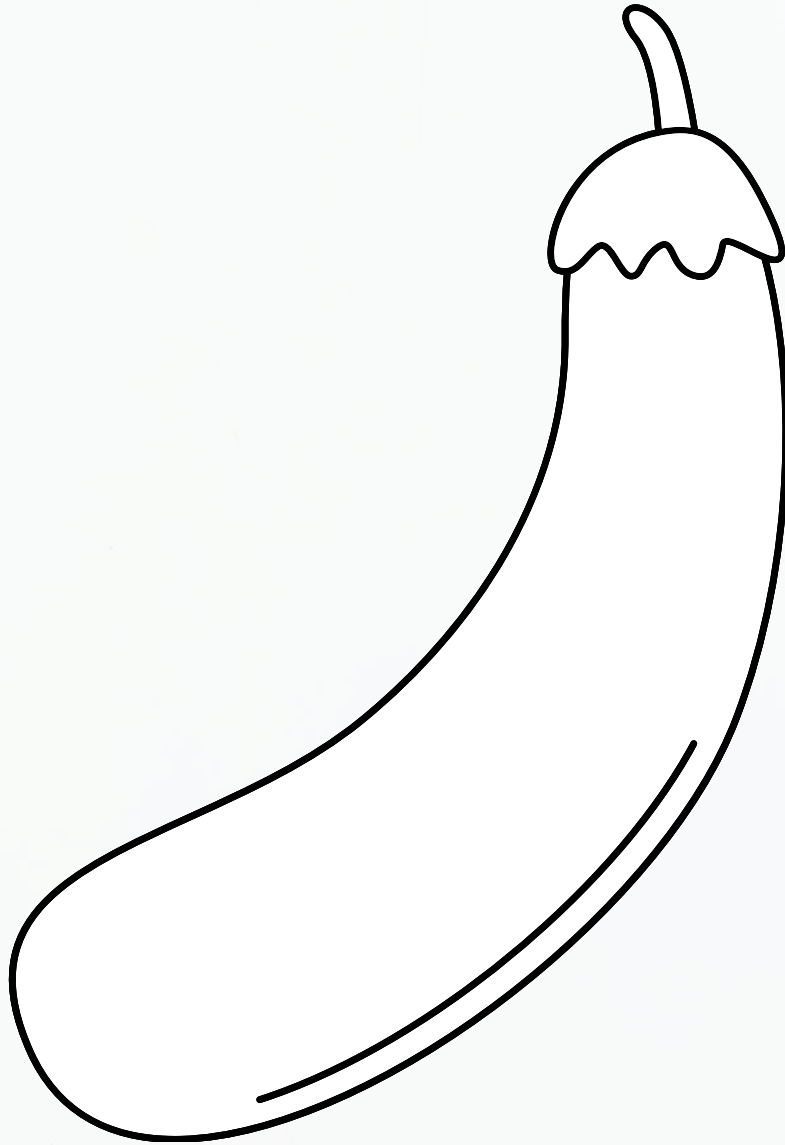

Name: _____

Date: _____

Alphabet A to Z

Color the drawing and trace the word

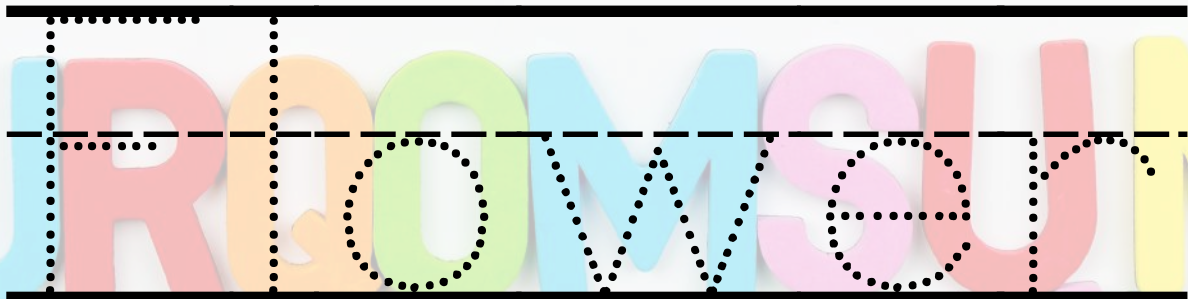
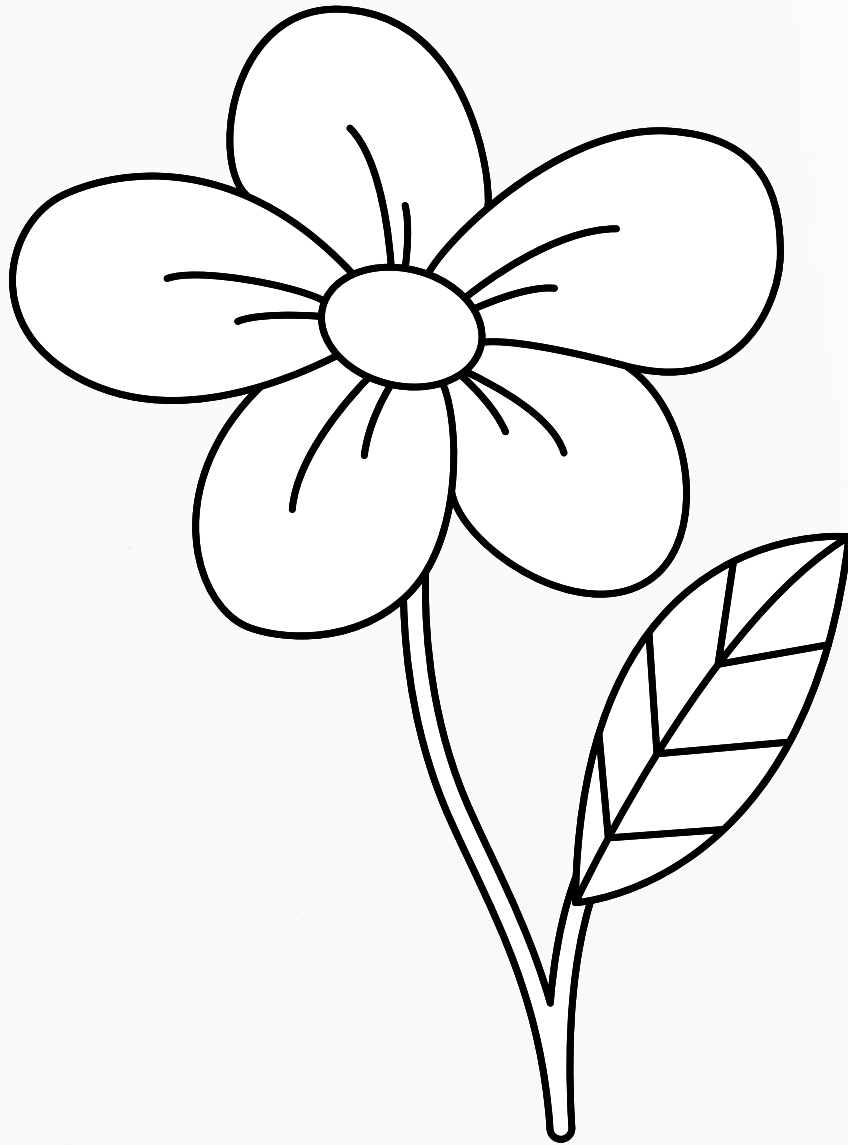

Name: _____

Date: _____

Alphabet A to Z

Color the drawing and trace the word

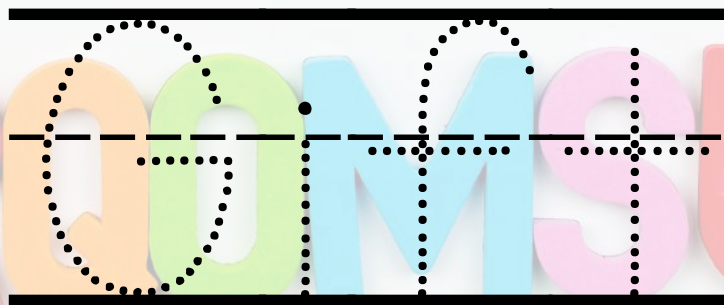
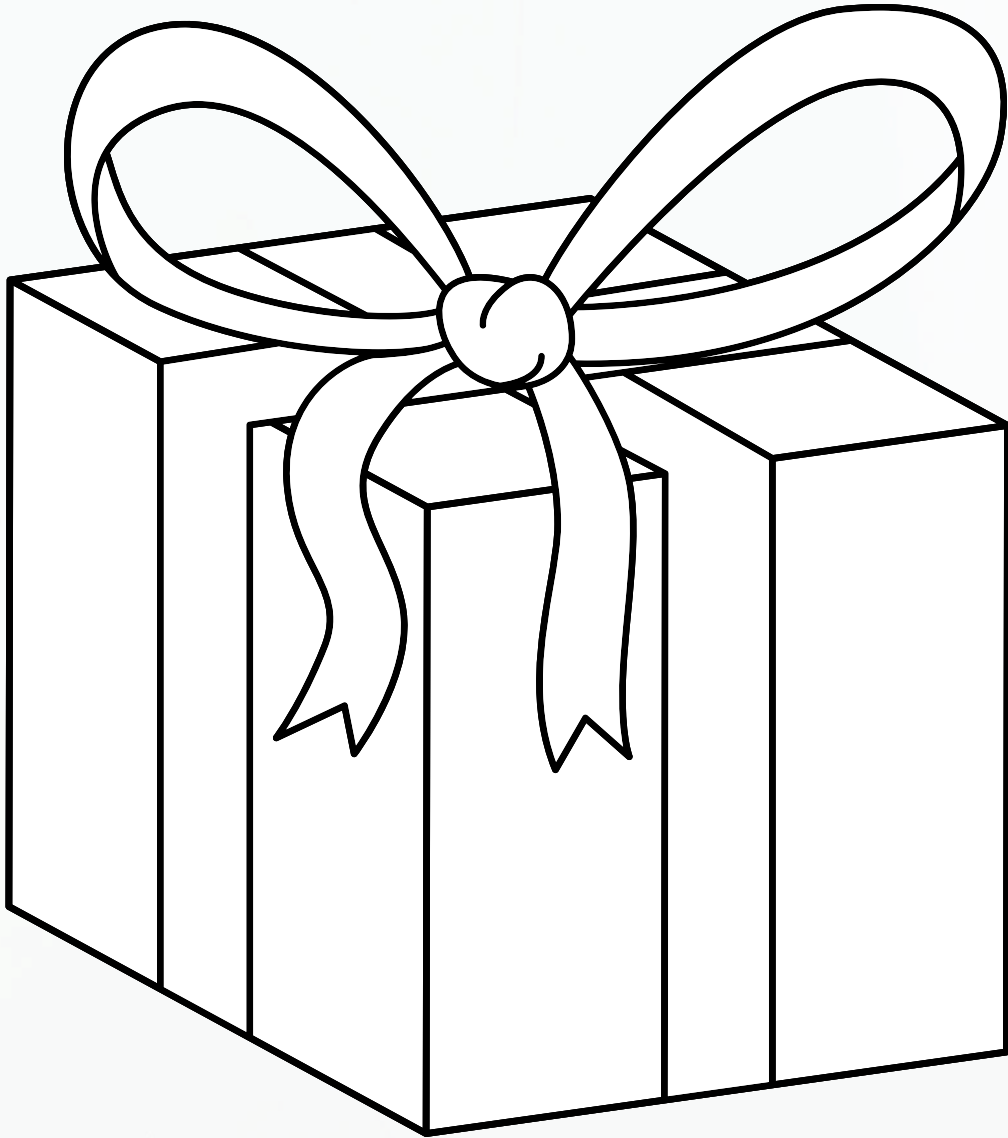

Name: _____

Date: _____

Alphabet A to Z

Color the drawing and trace the word

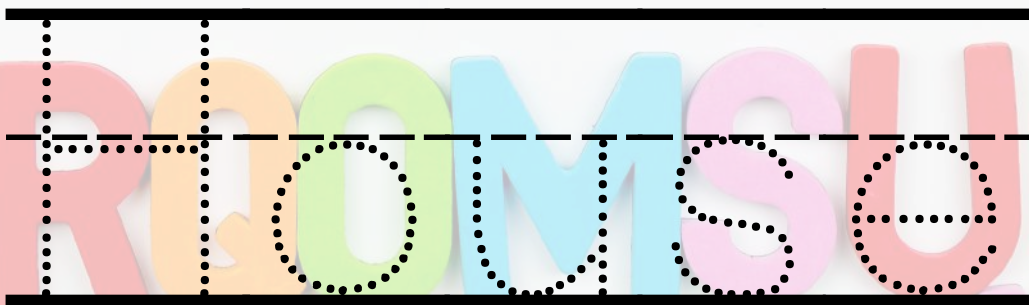
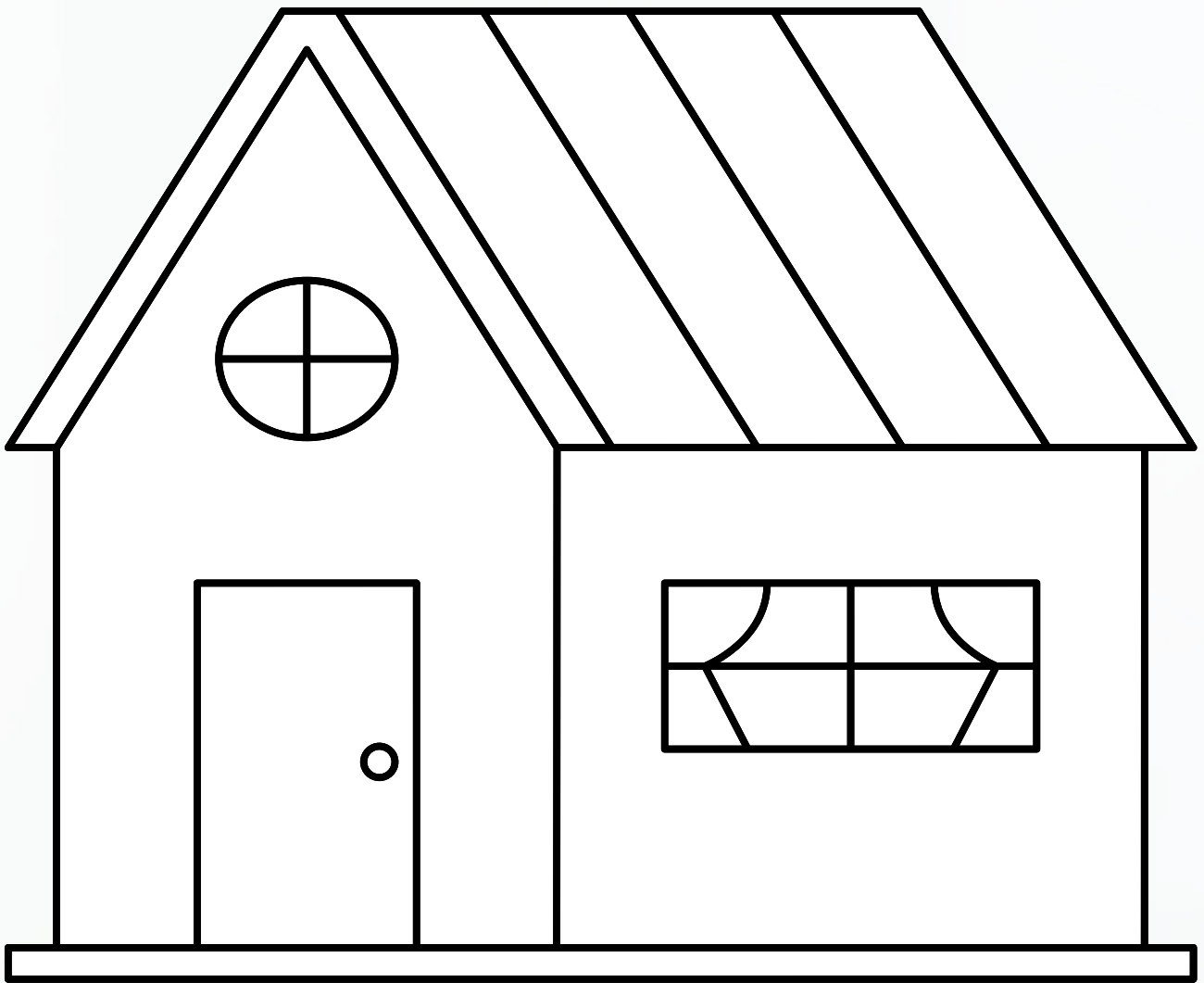

Name: _____

Date: _____

Alphabet A to Z

Color the drawing and trace the word



Ice cream

Name: _____

Date: _____

Alphabet A to Z

Color the drawing and trace the word

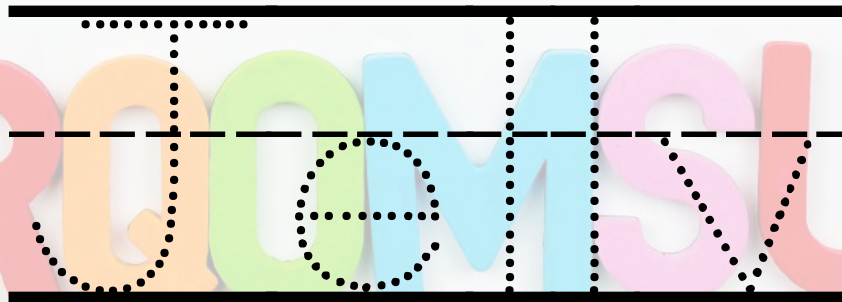
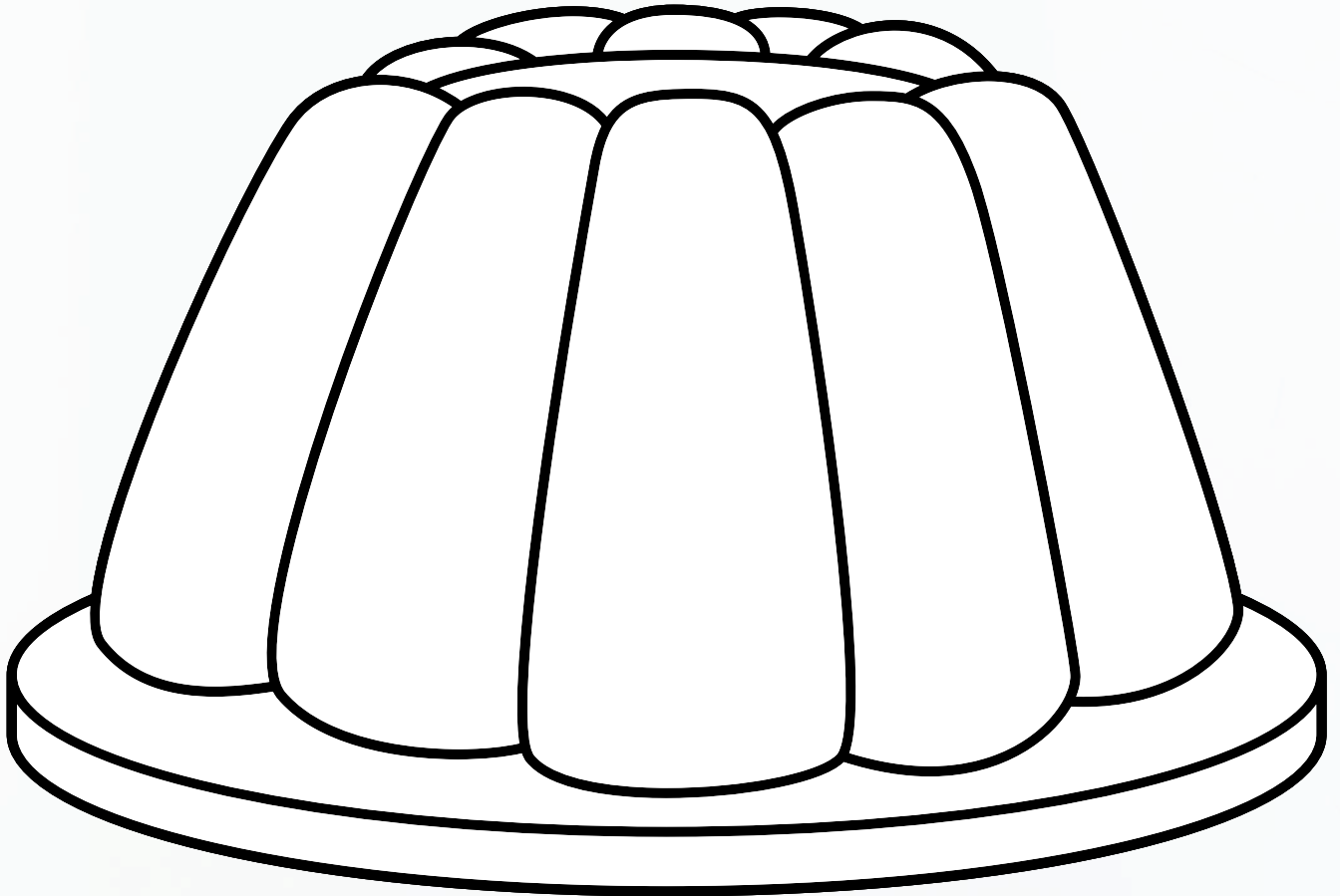

Name: _____

Date: _____

Alphabet A to Z

Color the drawing and trace the word

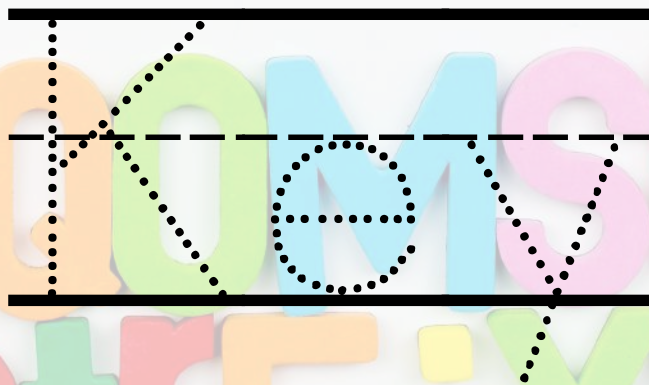
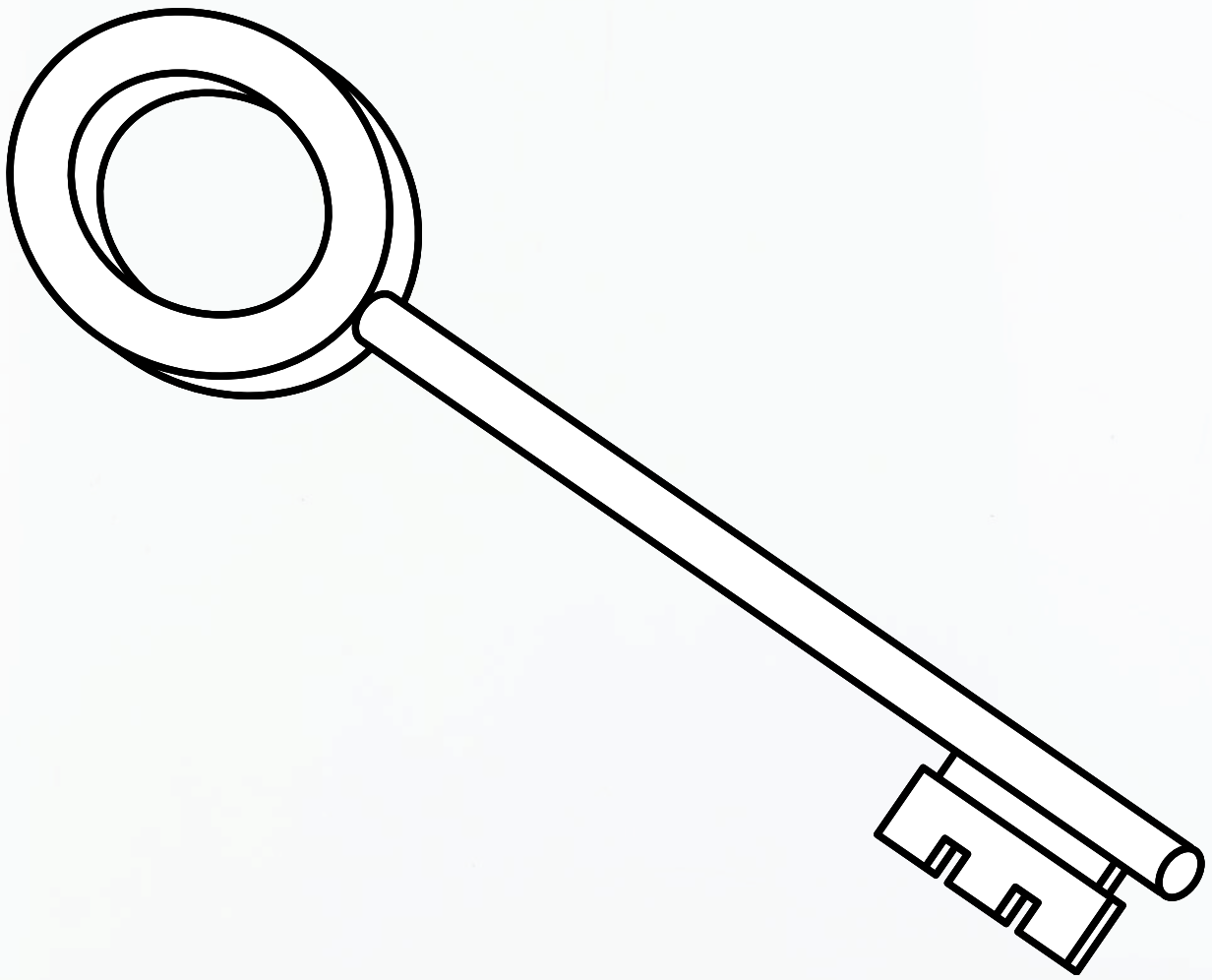

Name: _____

Date: _____

Alphabet A to Z

Color the drawing and trace the word

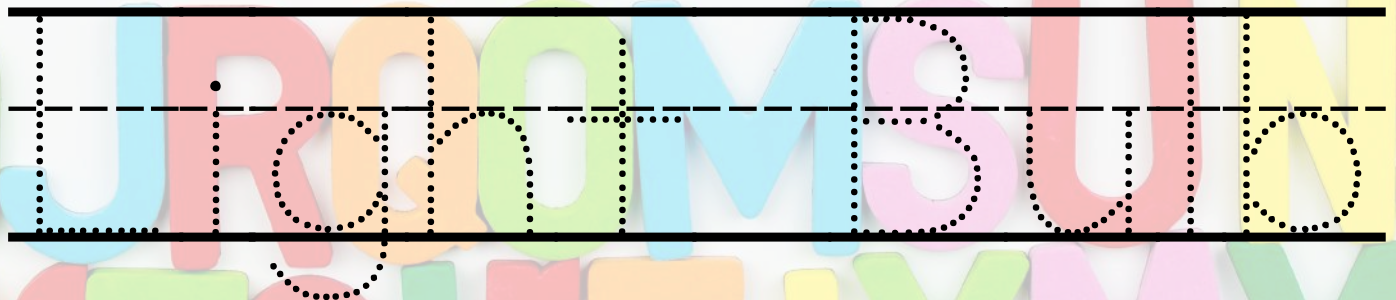
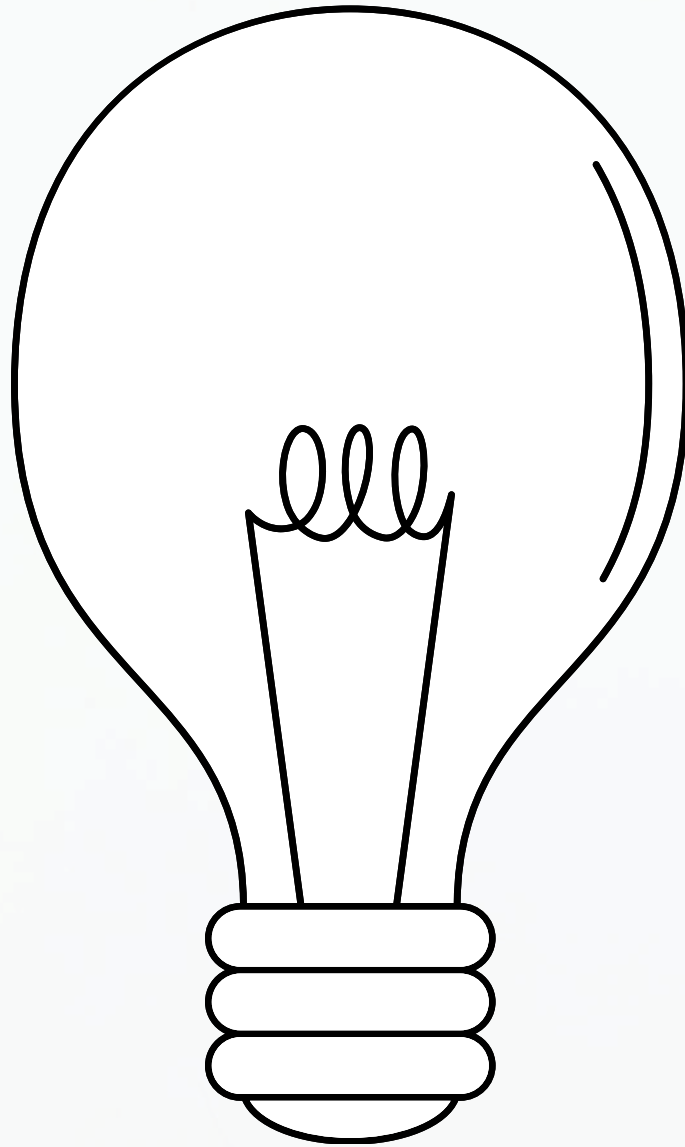

Name: _____

Date: _____

Alphabet A to Z

Color the drawing and trace the word

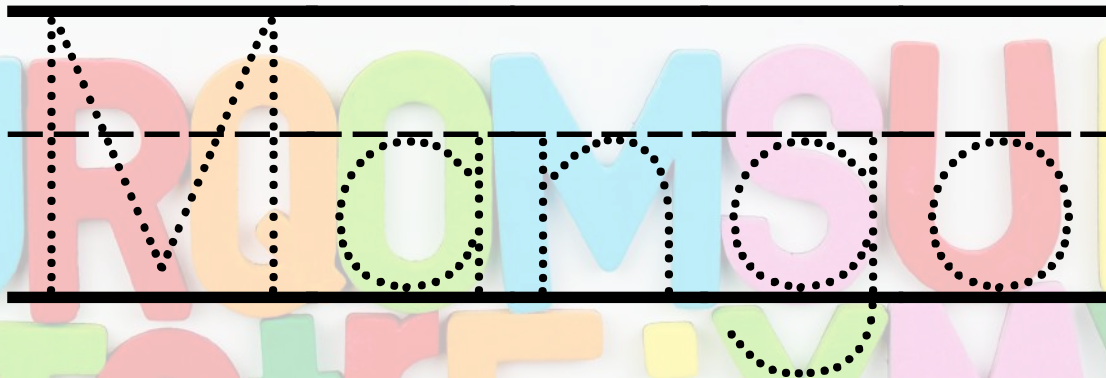
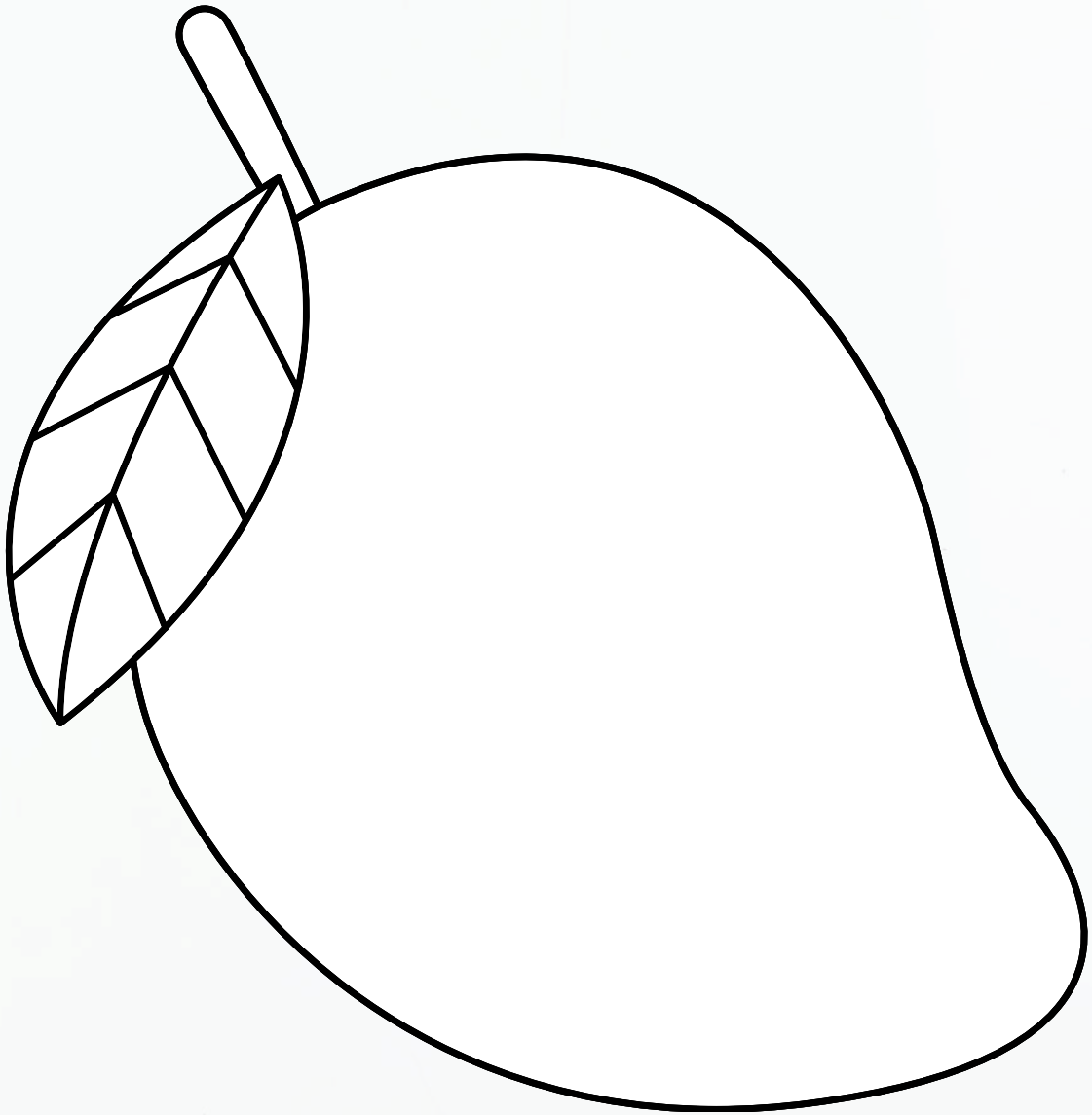

Name: _____

Date: _____

Alphabet A to Z

Color the drawing and trace the word

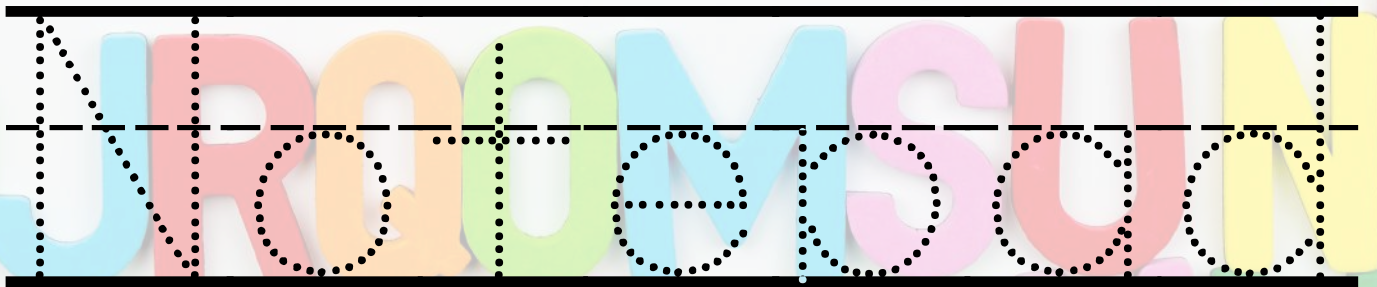
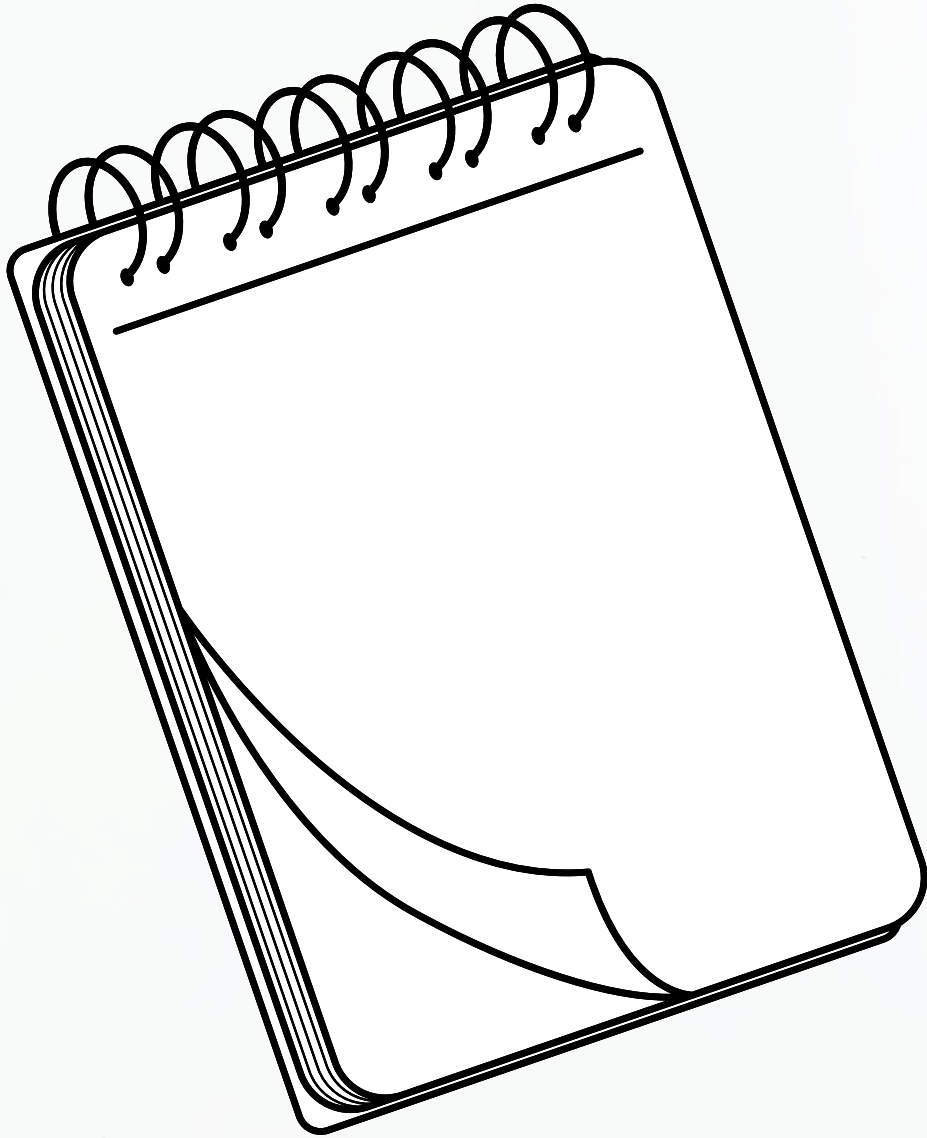

Name: _____

Date: _____

Alphabet A to Z

Color the drawing and trace the word

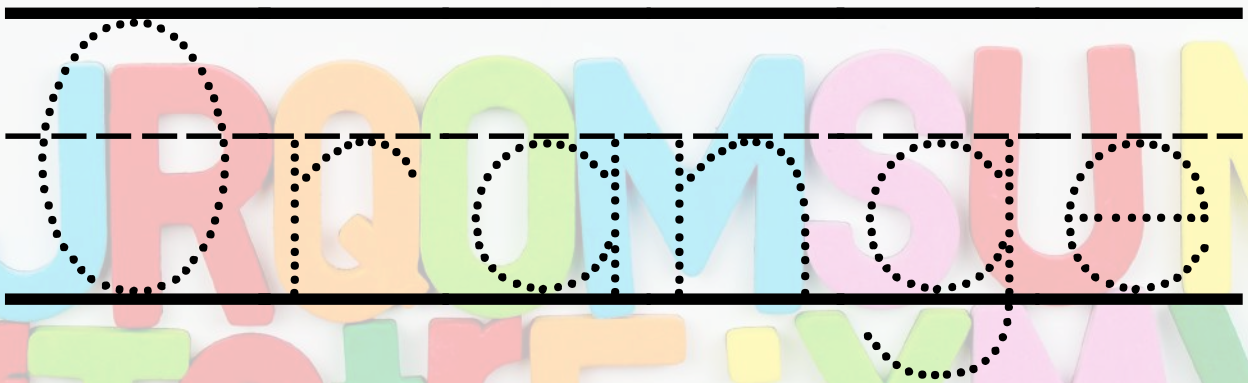
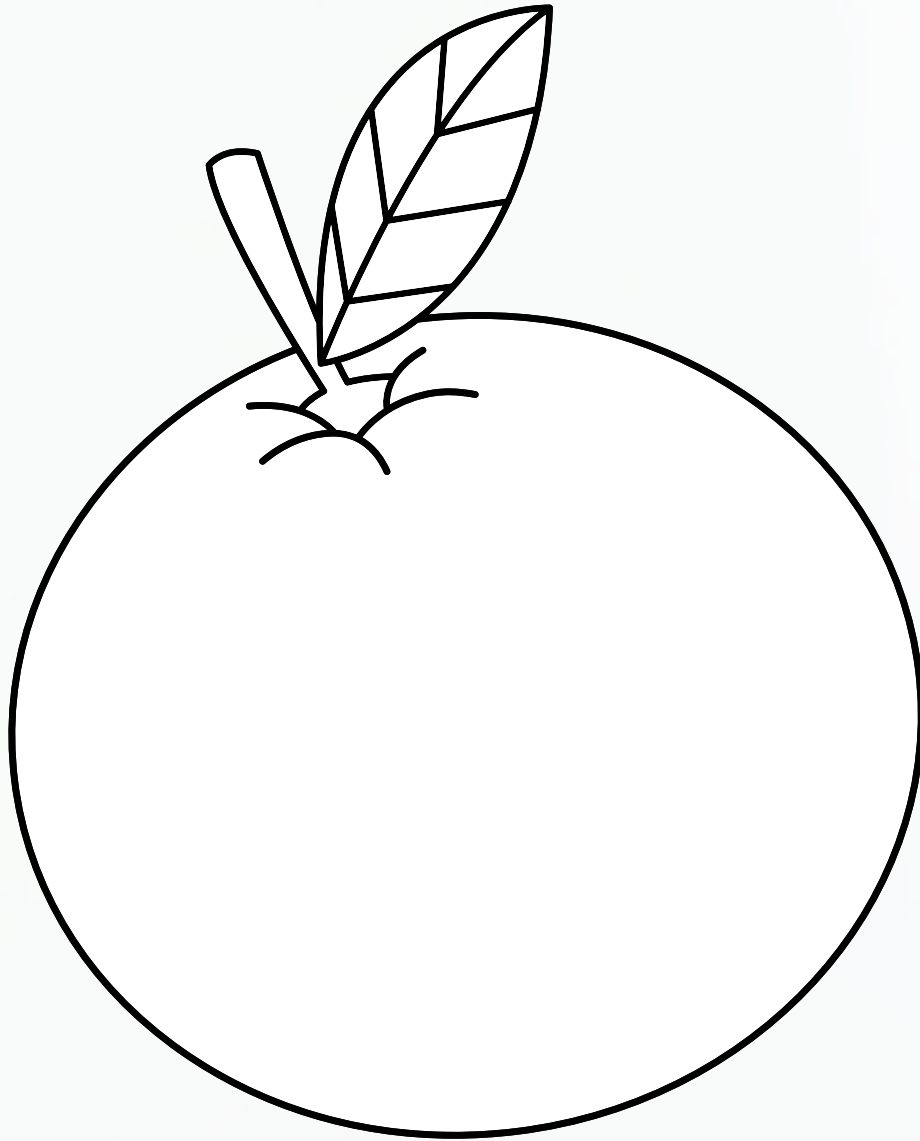

Name: _____

Date: _____

Alphabet A to Z

Color the drawing and trace the word

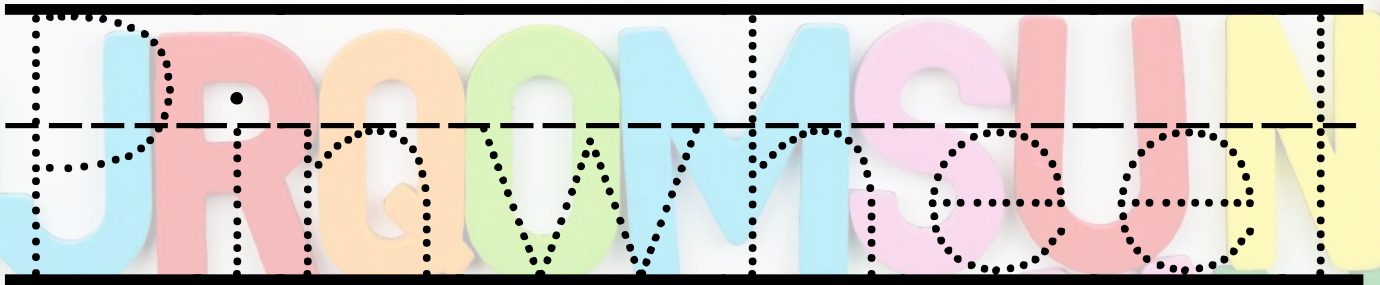
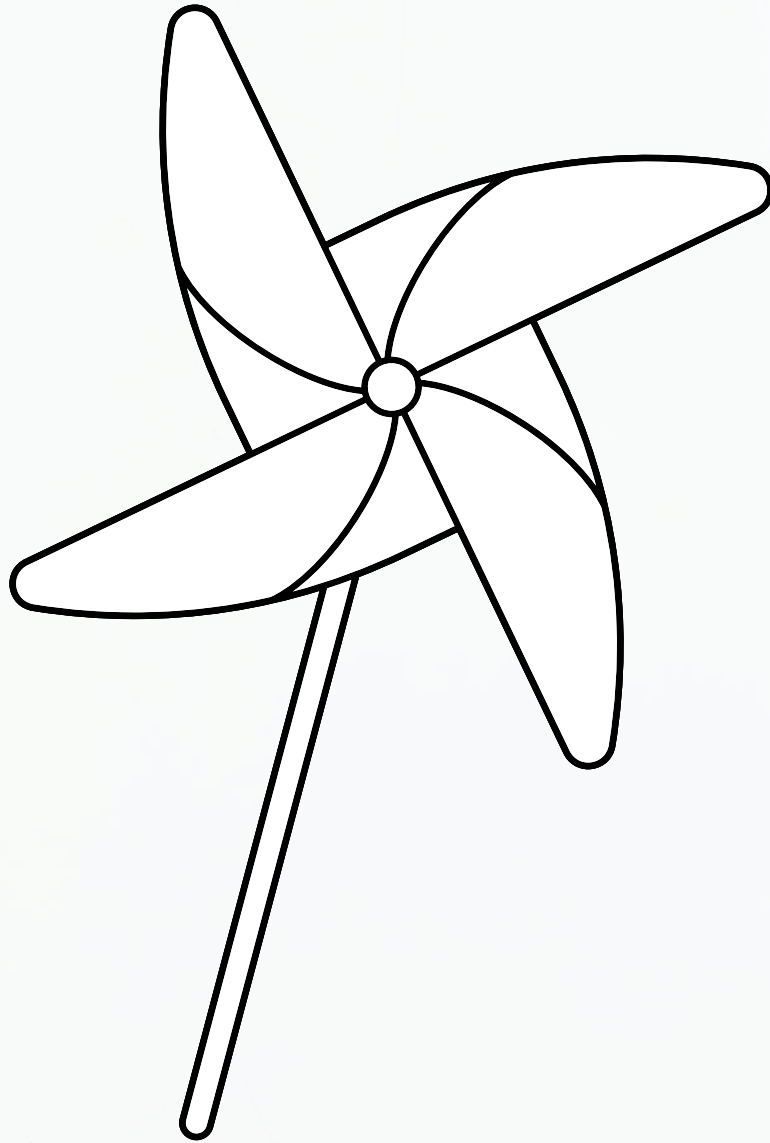

Name: _____

Date: _____

Alphabet A to Z

Color the drawing and trace the word

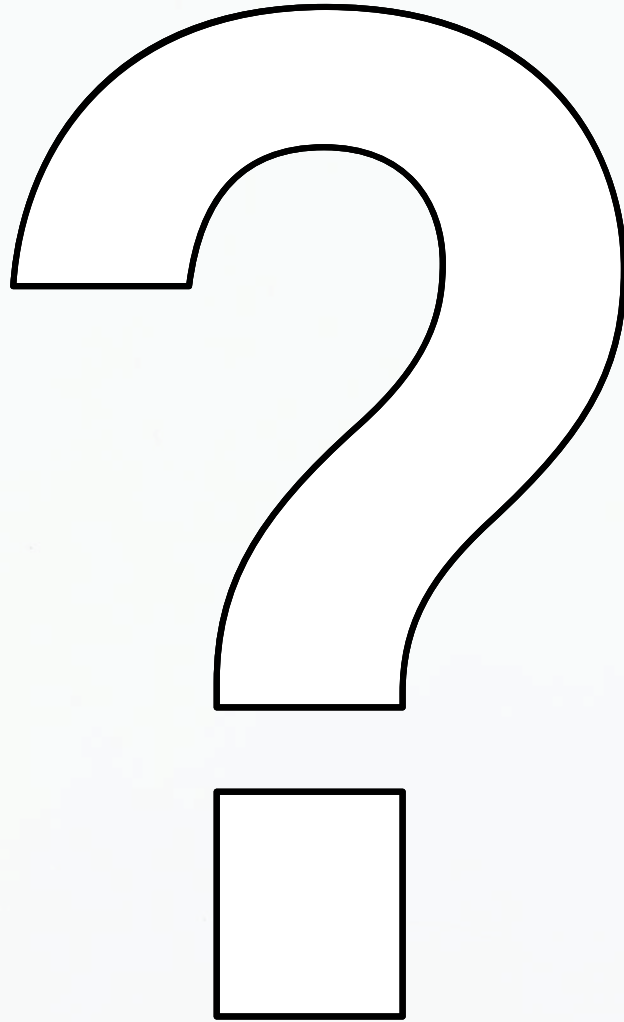

Question

Mark

Name: _____

Date: _____

Alphabet A to Z

Color the drawing and trace the word

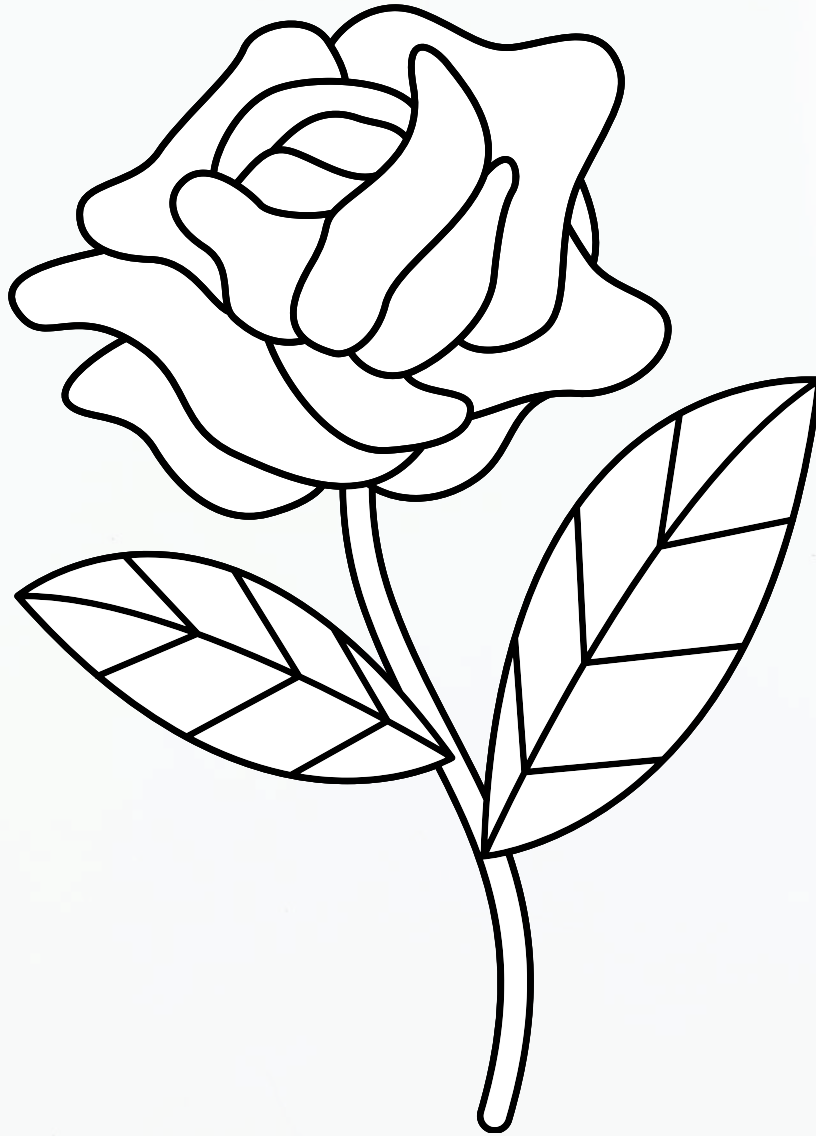

Name: _____

Date: _____

Alphabet A to Z

Color the drawing and trace the word

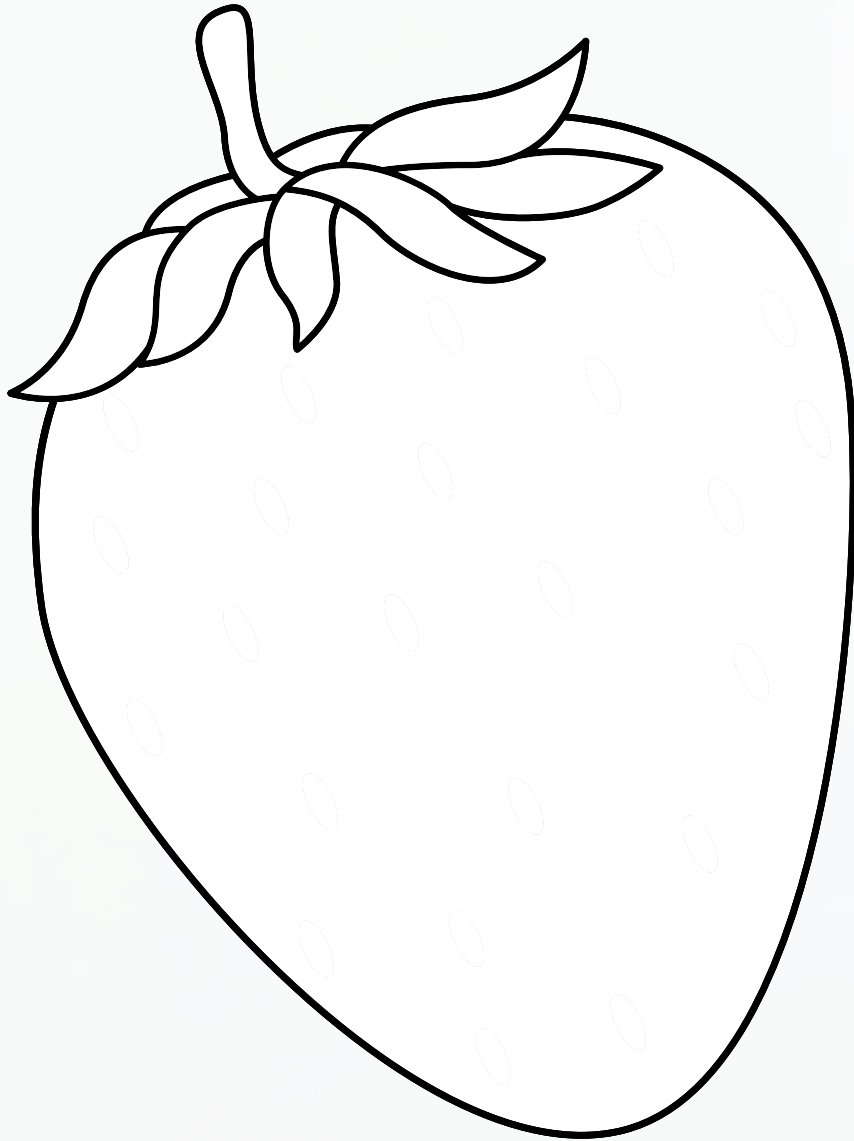

Strawberry

Name: _____

Date: _____

Alphabet A to Z

Color the drawing and trace the word

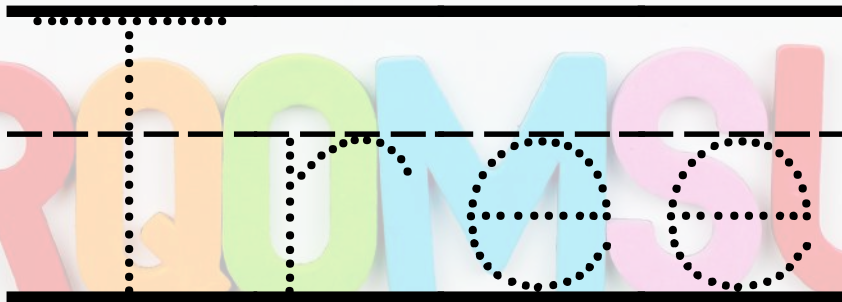
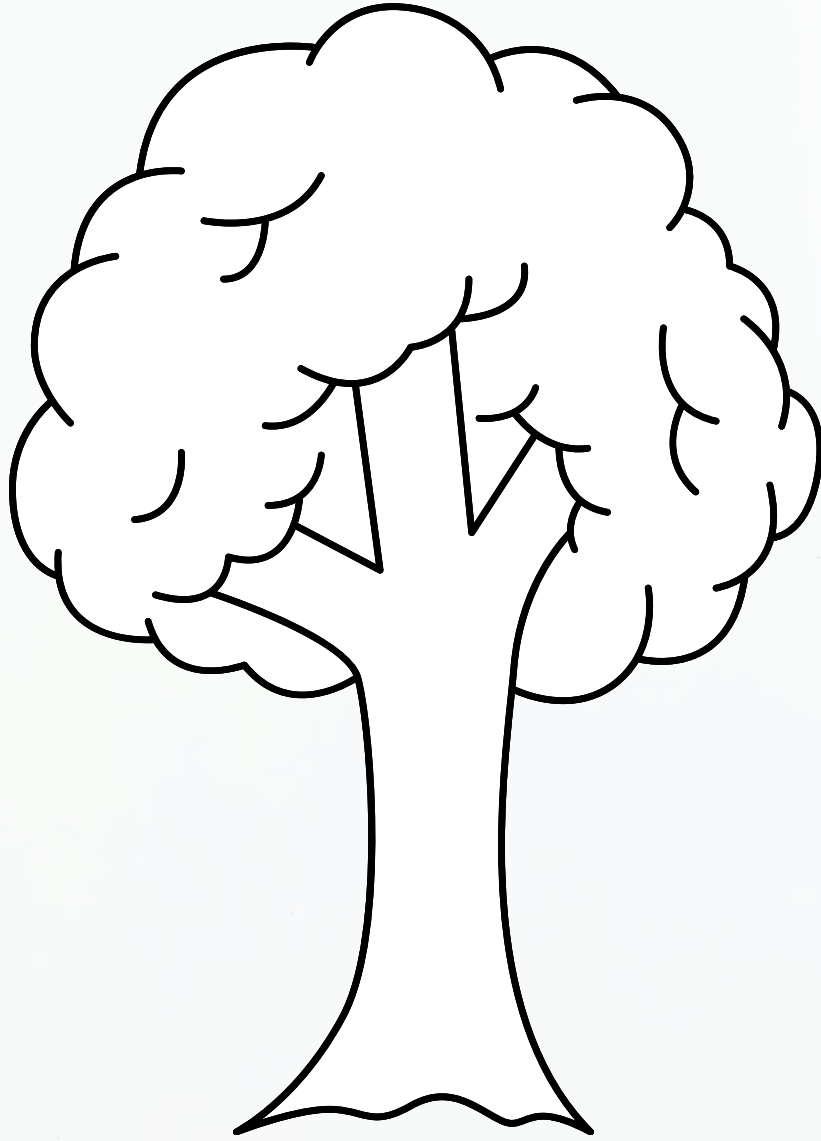

Name: _____

Date: _____

Alphabet A to Z

Color the drawing and trace the word



Name: _____

Date: _____

Alphabet A to Z

Color the drawing and trace the word

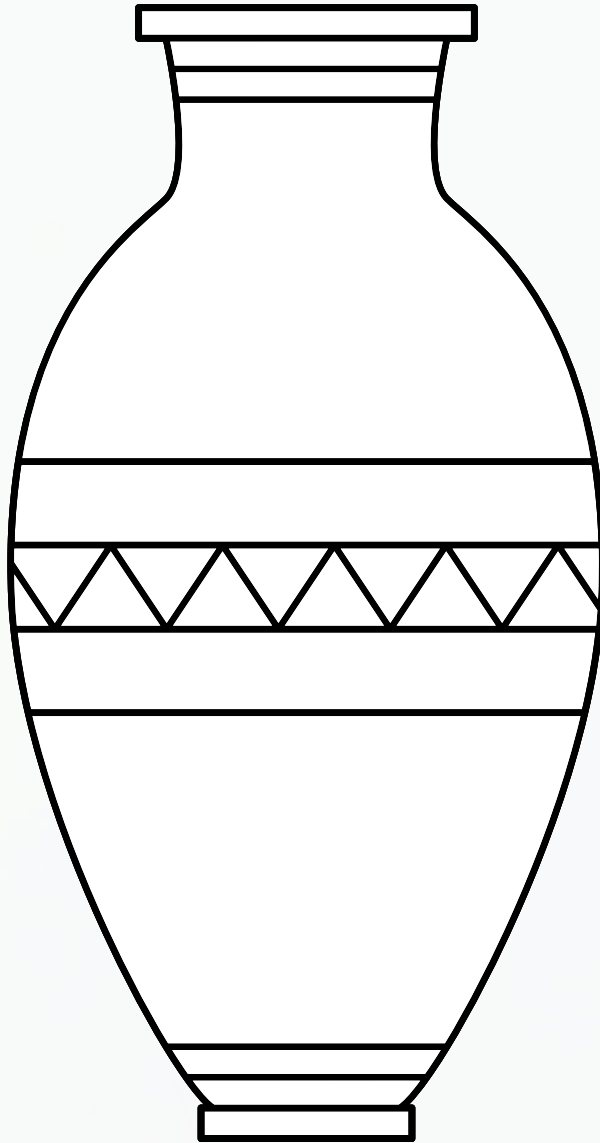

Name: _____

Date: _____

Alphabet A to Z

Color the drawing and trace the word

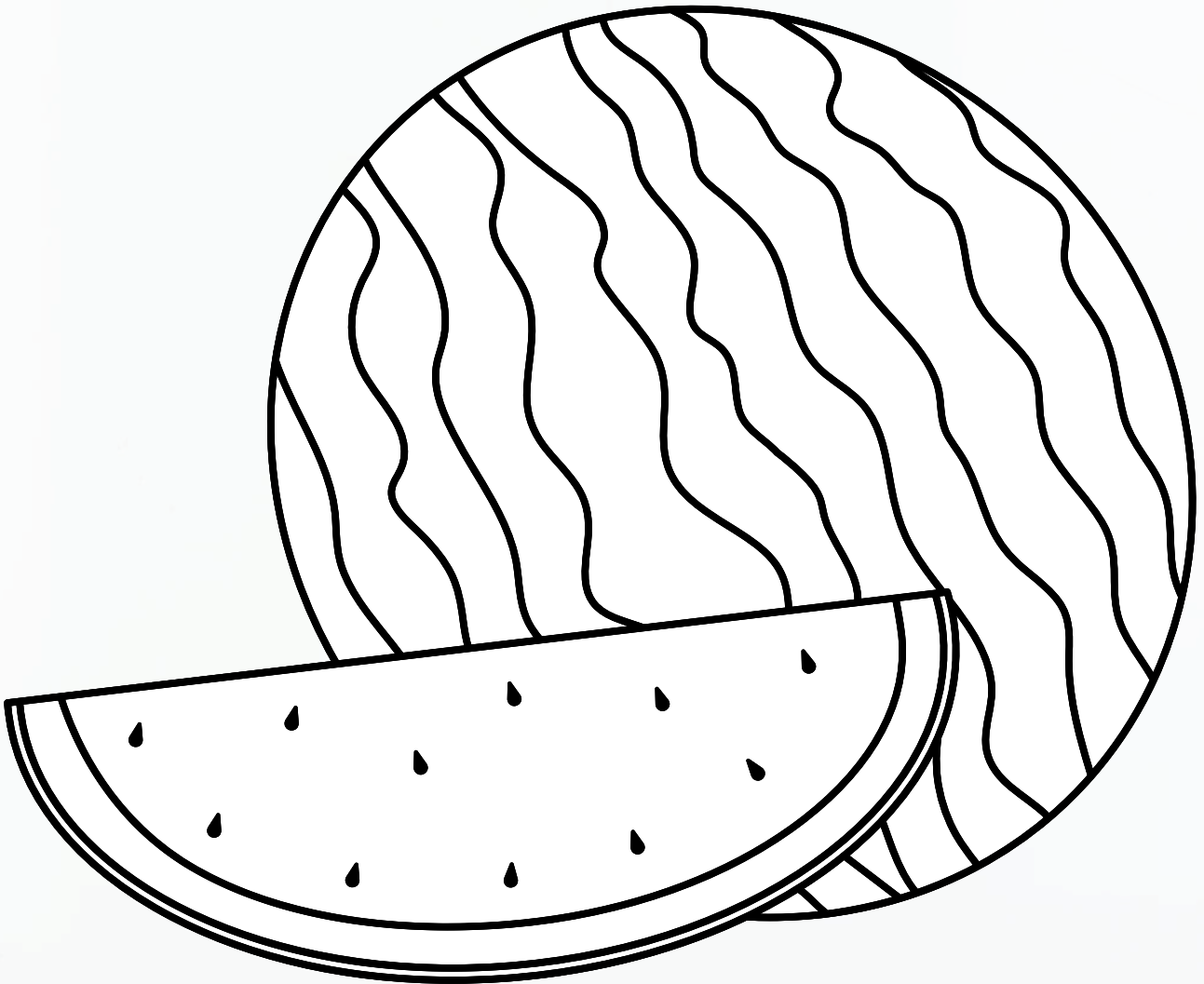

Watermelon

Name: _____

Date: _____

Alphabet A to Z

Color the drawing and trace the word

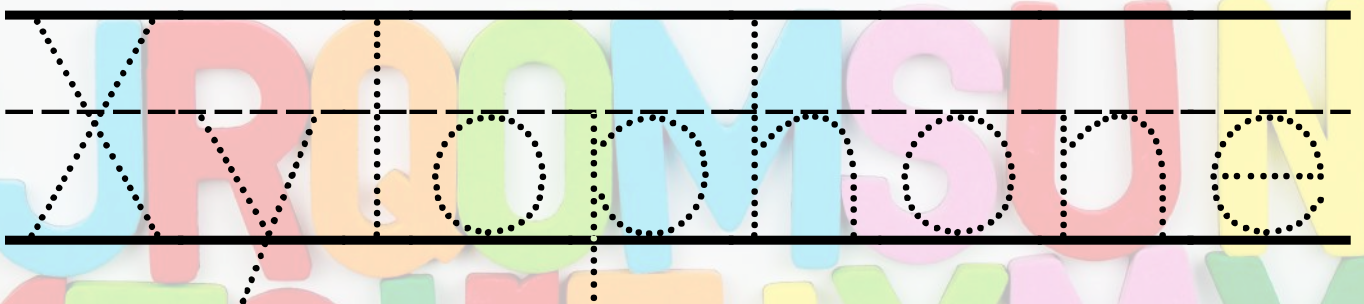
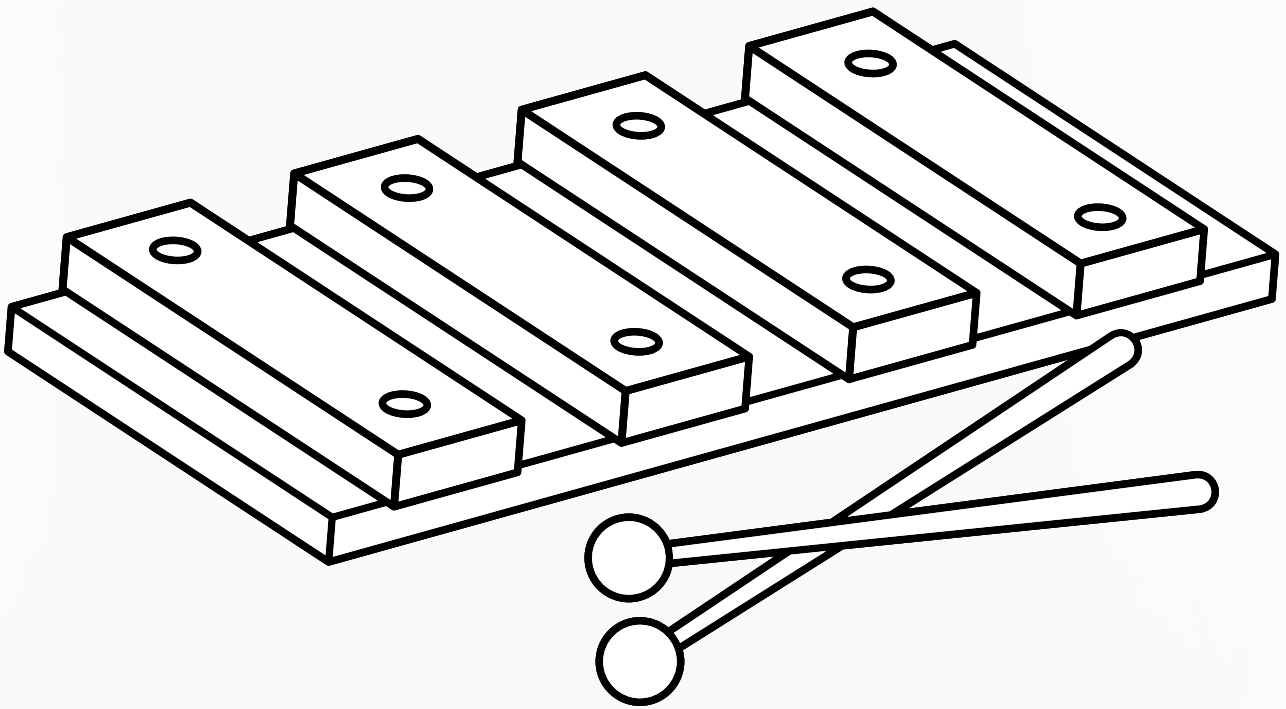

Name: _____

Date: _____

Alphabet A to Z

Color the drawing and trace the word

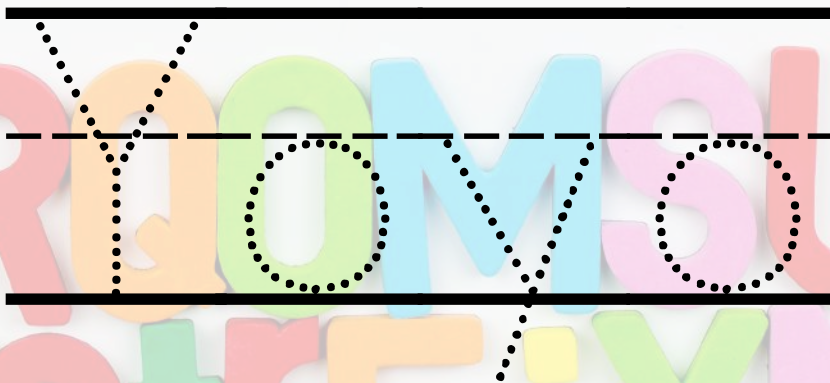
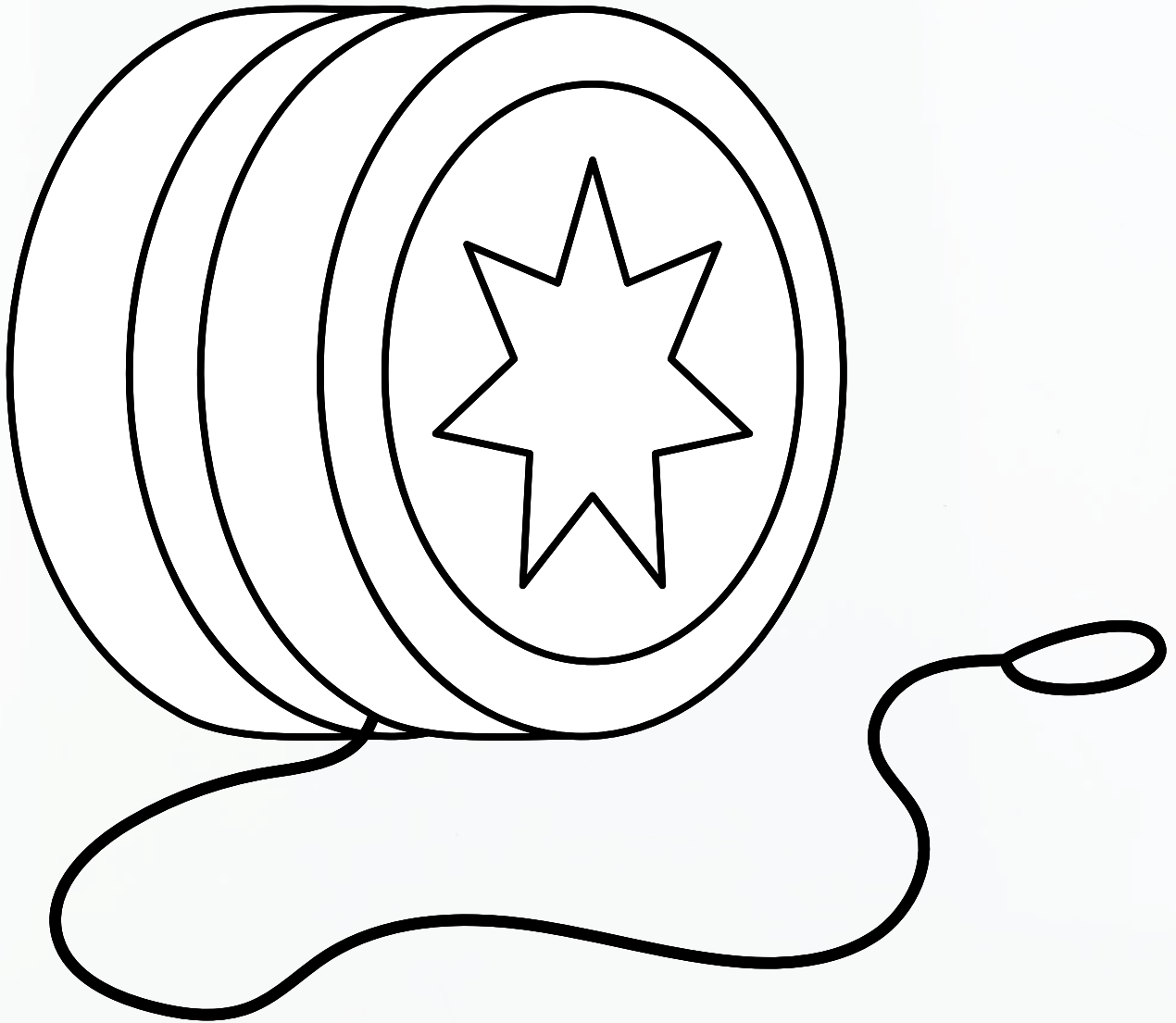

Name: _____

Date: _____

Alphabet A to Z

Color the drawing and trace the word

